

↑ **BOW**

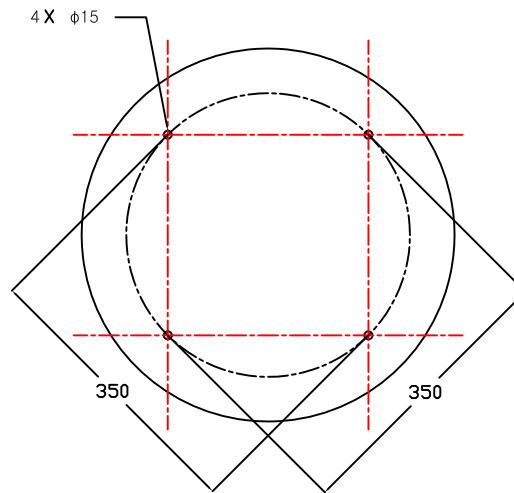

Mounting Surface Patten(unit : mm)

Z12 Mounting Hole Diagram	-	-	-	-	x x	-
Name	Q'ty	Material	Per Weight	Total Weight	Dimension	Reference
Designed by H.S. Lee	Checked by G.S.RYU	Approved B.W.JIN	Drawing No Z12A00		Date 2008. 05. 26	
 (주)한국네트워크시스템즈 Korea Network Systems	Model name SuperTrackZ12				Scale -	
	Filename Z12A00_mounting hole diagram.dwg				Angle THIRD	